

1	2 1 1 0	1
	1	
	- 1 2 3	

1	2 1 0 1	1
	1	
	- 1 2 4	

1	0 2 2 0	1
	1	
	- 1 3 2	

1	2 0 0 2	1
	1	
	- 1 3 4	

1	2 0 1 1	1
	1	
	- 1 4 2	

1	1 2 1 0	1
	1	
	- 1 4 3	

1	2 2 0 0	1
	1	
	- 2 1 3	

1	0 0 2 2	1
	1	
	- 2 1 4	

1	1 2 0 1	1
	1	
	- 2 3 1	

1	0 2 1 1	1
	1	
	- 2 3 4	

1	2 0 2 0	1
	1	
	- 2 4 1	

1	0 2 0 2	1
	1	
	- 2 4 3	

1	1 1 2 0	1
	1	
	- 3 1 2	

1	1 0 2 1	1
	1	
	- 3 1 4	

1	0 2 2 0	1
	1	
	- 3 2 1	

1	2 0 0 2	1
	1	
	- 3 2 4	

1	0 1 2 1	1
	1	
	- 3 4 1	

1	1 1 0 2	1
	1	
	- 3 4 2	

1	2 2 0 0	1
	1	
	- 4 1 2	

1	0 0 2 2	1
	1	
	- 4 1 3	

1	1 0 1 2	1
	1	
	- 4 2 1	

1	0 1 1 2	1
	1	
	- 4 2 3	

1	2 0 2 0	1
	1	
	- 4 3 1	

1	0 2 0 2	1
	1	
	- 4 3 2	

2	2 1 0 0	2
	2	
	1 - 2 3	

2	2 0 1 0	2
	2	
	1 - 2 4	

2	1 1 1 0	2
	2	
	1 - 3 2	

0 1 1 1

1 - 3 4

2 0 0 1

1 - 4 2

1 2 0 0

1 - 4 3

1 0 1 1

2 - 1 3

1 1 0 1

2 - 1 4

0 2 1 0

2 - 3 1

0 2 0 1

2 - 3 4

1 1 1 0

2 - 4 1

0 1 1 1

2 - 4 3

1 0 2 0









3 - 1 2





0 1 2 0



3 - 1 4

1 0 1 1

3 - 2 1

1 1 0 1

















3 - 2 4

0 0 2 1

3 - 4 1

1 0 0 2

3 - 4 2

1 1 1 0











4 - 1 2



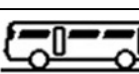

0 1 1 1



4 - 1 3

0 1 0 2

4 - 2 1

2 0 0 1 2 2







4 - 2 3

2 1 0 1 1 2







4 - 3 1

2 1 1 0 1 2











4 - 3 2

3 2 0 0 0 3

1 2 - 3

3 0 2 0 0 3









1 2 - 4

3 0 0 2 0 3













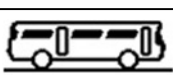

1 3 - 2

3 0 0 0 2 3





1 3 - 4

3 0 0 0 2 3

1 4 - 2

3 0 0 2 0 3

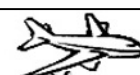
1 4 - 3

3	0 2 0 0	3
	2 1 - 3	

3	2 0 0 0	3
	2 1 - 4	

3	2 0 0 0	3
	2 3 - 1	

3	0 2 0 0	3
	2 3 - 4	

3	0 0 2 0	3
	2 4 - 1	

3	0 0 0 2	3
	2 4 - 3	

3	0 0 1 1	3
	3 1 - 2	

3	1 1 0 0	3
	3 1 - 4	

3	0 1 1 0	3
	3 2 - 1	

3 1 0 0 1 3

















3 2 - 4

3 1 0 1 0 3

3 4 - 1

3 0 1 0 1 3

3 4 - 2

3 0 1 0 1 3







4 1 - 2

3 1 0 1 0 3











4 1 - 3

3 1 0 0 1 3

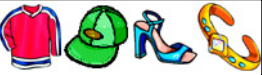
4 2 - 1

3 0 1 1 0 3

















4 2 - 3

3 1 1 0 0 3

4 3 - 1

3 0 0 1 1 3

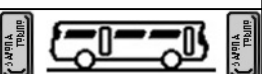
4 3 - 2



4	1 0 0 0	4
	4	
	1 2 3 -	

4	1 0 0 0	4
	4	
	1 2 4 -	

4	1 0 0 0	4
	4	
	1 3 2 -	

4	1 0 0 0	4
	4	
	1 3 4 -	

4	1 0 0 0	4
	4	
	1 4 2 -	

4	1 0 0 0	4
	4	
	1 4 3 -	

4	0 1 0 0	4
	4	
	2 1 3 -	

4	0 1 0 0	4
	4	
	2 1 4 -	

4	0 1 0 0	4
	4	
	2 3 1 -	

4	0 1 0 0	4
	4	
2 3 4 -		

4	0 1 0 0	4
	4	
2 4 1 -		

4	0 1 0 0	4
	4	
2 4 3 -		

4	0 0 1 0	4
	4	
3 1 2 -		

4	0 0 1 0	4
	4	
3 1 4 -		

4	0 0 1 0	4
	4	
3 2 1 -		





4	0 0 1 0	4
	4	
3 2 4 -		

4	0 0 1 0	4
	4	
3 4 1 -		





4	0 0 1 0	4
	4	
3 4 2 -		



4	0 0 0 1	4
		
	4	
		
		
4	1 2 -	



4	0 0 0 1	4
		
	4	
		
		
4	1 3 -	

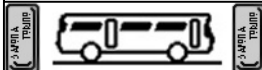
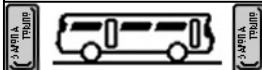

4	0 0 0 1	4
		
	4	
		
		
4	2 1 -	



4	0 0 0 1	4
		
	4	
		
		
4	2 3 -	



4	0 0 0 1	4
		
	4	
		
		
4	3 1 -	



4	0 0 0 1	4
		
	4	
		
		
4	3 2 -	



В		В
	<b>ВЛЦЦЦЦ</b>	
		

В		В
	<b>ВЛЦЦЦЦ</b>	
		

В		В
	<b>ВЛЦЦЦЦ</b>	
		

В		В
	<b>ВЛЦЦЦЦ</b>	
		

В		В
	<b>ВЛЦЦЦЦ</b>	
		

В		В
	<b>ВЛЦЦЦЦ</b>	
		



7 6 5 4 3 2 1

Tractor, Airplane, Train, Sailboat

A vertical stack of seven horizontal rows. The top row shows a cityscape. The following seven rows are purple and each contains a number in a circle (7, 6, 5, 4, 3, 2, 1) followed by four icons: a tractor, an airplane, a train, and a sailboat.



7 6 5 4 3 2 1

Tractor, Airplane, Train, Sailboat

A vertical stack of seven horizontal rows. The top row shows a cityscape. The following seven rows are orange and each contains a number in a circle (7, 6, 5, 4, 3, 2, 1) followed by four icons: a tractor, an airplane, a train, and a sailboat.



7 6 5 4 3 2 1

Tractor, Airplane, Train, Sailboat

A vertical stack of seven horizontal rows. The top row shows a cityscape. The following seven rows are green and each contains a number in a circle (7, 6, 5, 4, 3, 2, 1) followed by four icons: a tractor, an airplane, a train, and a sailboat.



7 6 5 4 3 2 1

Tractor, Airplane, Train, Sailboat

A vertical stack of seven horizontal rows. The top row shows a cityscape. The following seven rows are blue and each contains a number in a circle (7, 6, 5, 4, 3, 2, 1) followed by four icons: a tractor, an airplane, a train, and a sailboat.



7 6 5 4 3 2 1

Tractor, Airplane, Train, Sailboat

A vertical stack of seven horizontal rows. The top row shows a cityscape. The following seven rows are yellow and each contains a number in a circle (7, 6, 5, 4, 3, 2, 1) followed by four icons: a tractor, an airplane, a train, and a sailboat.



7 6 5 4 3 2 1

Tractor, Airplane, Train, Sailboat

A vertical stack of seven horizontal rows. The top row shows a cityscape. The following seven rows are red and each contains a number in a circle (7, 6, 5, 4, 3, 2, 1) followed by four icons: a tractor, an airplane, a train, and a sailboat.